

REELPOWER

OIL & GAS

RADOIL  TULSAPOWER

Standard and custom winches
to meet your exact needs

- 2 Position
- Motion Compensated
- Air, hydraulic or electrical powered
- Wire rope, hydraulic, electrical or fiber optic umbilicals
- NEMA 4X or explosion proof systems

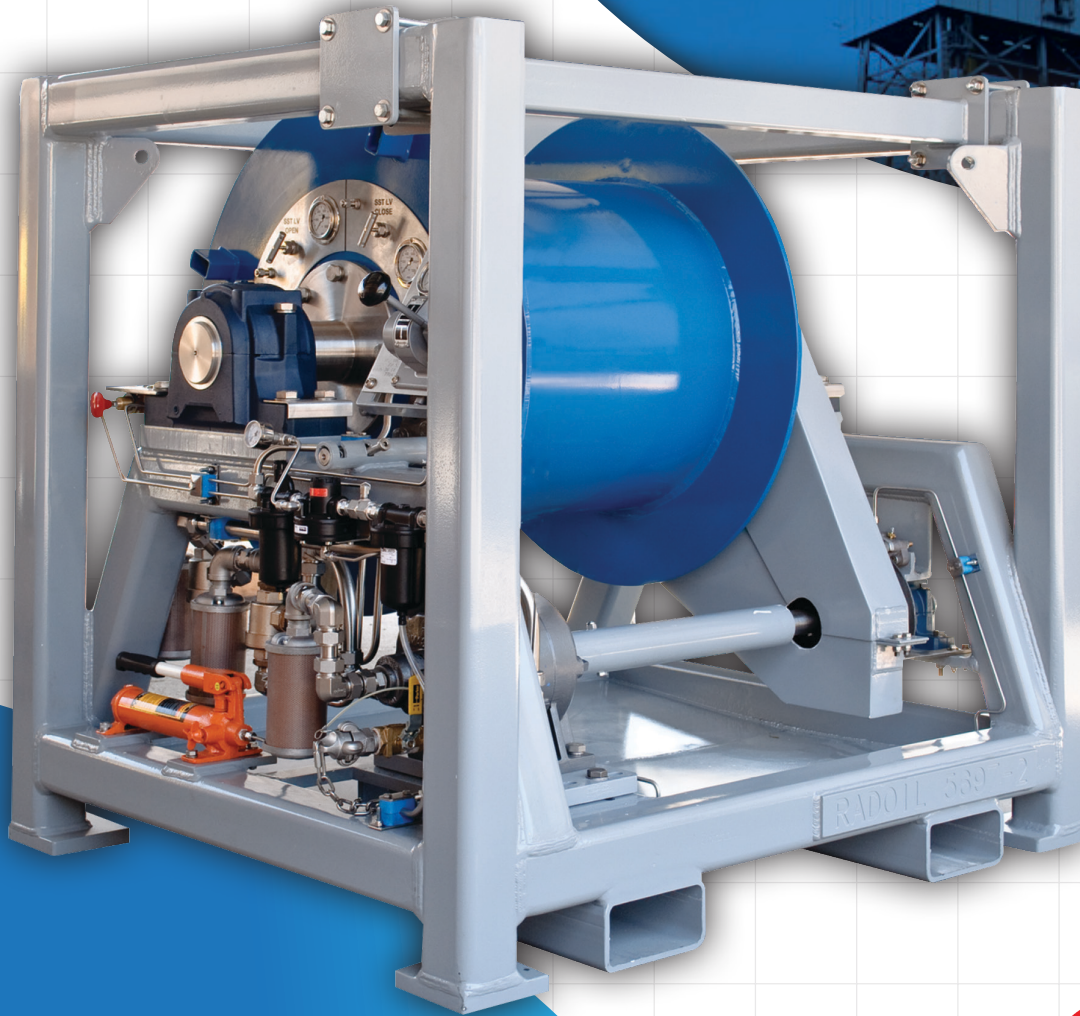

WE SOLVE DEEPWATER PROBLEMS

Our goal is to identify challenges, design innovative solutions and manufacture quality products that solve your deepwater problems. Our business is saving you time and money.



8780 West Road
Houston, TX 77064
(713)937-4494
info@radoil.com
www.radoil.com

WINCHES

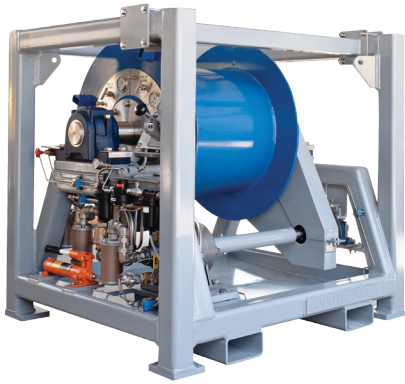

Hydraulic Umbilical Winch

Compact service package with air motor and hydraulic control panel

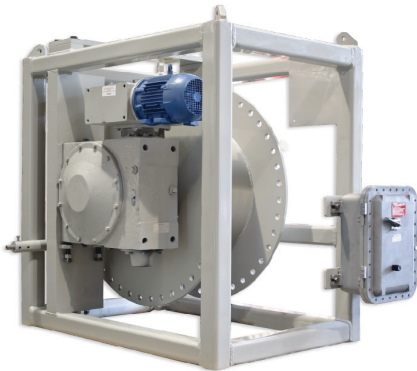

Instrument Supporting Winch

Suspends equipment below rigs for current monitoring similar operations, wormgear drive provides natural braking

Radoil 2-position winch with hold back

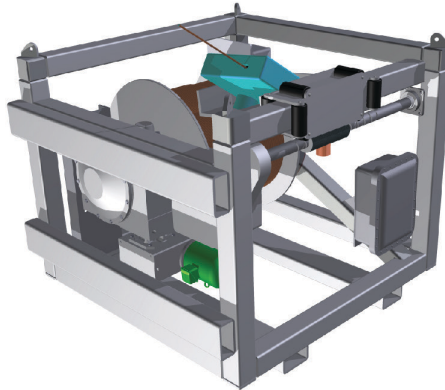

Normal payout to derrick sheave

Levelwind tractor provides holdback to insure tight wrap of cable on spool
*combines pull with spool for high loads

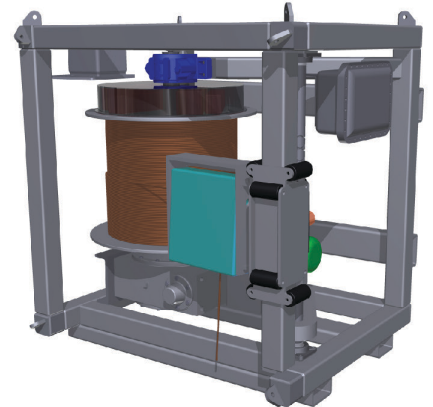

Payout directly into well

Radoil winch-motion compensated

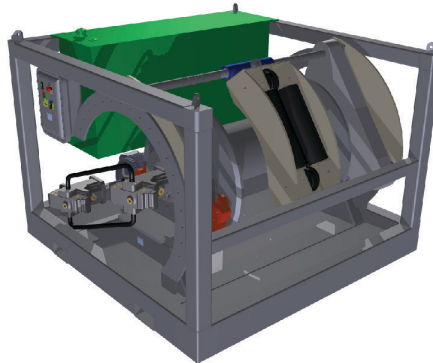

Provides for high capacity pulling along with push button control to establish motion compensation for critical landing operations.

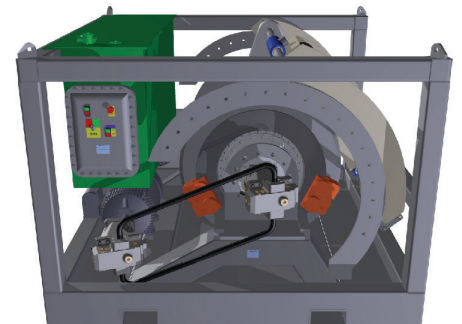

REELPOWER
OIL & GAS
RADOIL TULSAPOWER

8780 West Road | Houston, TX 77064
(713)937-4494 | info@radoil.com
www.radoil.com

Our products are based upon technology aimed at providing you with enhanced quality and reliability. When service is needed, our customer support engineers will provide efficient and responsive support.